

HAGENSTEEL Profiler®

T06 External Roof Blind



T06 External Roof Blind

Horizontal Awning

Product Introduction



With a precise and sturdy structure design, the new upgraded version of outdoor External Roof Blind is the best partner for various types of sunrooms, skylights, atriums, patios and terraces, making them truly a sight of life and leisure.



Enjoy high-end sunshade

T06 External Roof Blind

Horizontal Awning

Product Introduction



External Roof Blind is widely used for sunroom roofs, building skylights, patios and more. T06 External Roof Blind adopts a heavy-duty design, an all-aluminum alloy frame, and a standard China Dooya electric drive system, which have better durability, weather resistance, and mechanical performance.



T06 External Roof Blind controls the motor tension to stretch the spring inside the front tube to achieve fabric extension and retraction. The two sides are fixed guide rails, with embedded moving assemblies to ensure smooth fabric movement.

T06 External Roof Blind

Horizontal Awning

Material selection

Product Selection T06 External Roof Blind This product is independently developed and designed by our company. The design principle and material selection are as follows:

- 1.The profile is made of **6063 aluminum alloy** by mold forming, and the surface is treated by powder spraying. It has light weight, high strength, beautiful appearance, and durability.
- 2.All mechanical parts are made of aluminum alloy by CNC precision machining. They have accurate dimensions and easy assembly.
- 3.The transmission part uses imported polymer customized synchronous belt. It has smooth transmission, cushioning and damping, oil and wear resistance, anti-aging, low noise, good performance, and can be used in the temperature range of **-20°C-80°C**.
- 4.Hardware accessories and screws are made of 304 stainless steel. They have high strength, corrosion resistance, good performance, and long durability.
- 5.The internal running structure uses an integrated sliding assembly, which runs smoothly, quietly, and more smoothly.
- 6.The driving part uses a tubular motor specially designed for sky curtain awnings (Note: the driving part can be optionally matched according to the product size and customer requirements: **China Dooya** or **French Somfy**)
- 7.The control part can use various control methods; wall switch, wireless remote control, timing control, wind-light-rain control, etc.
- 8.The fabric can be optionally matched with **China AOIUX** fabric or **Spanish Sauleda** fabric according to different customer scenarios.

T06 External Roof Blind

Horizontal Awning

Product exploded view

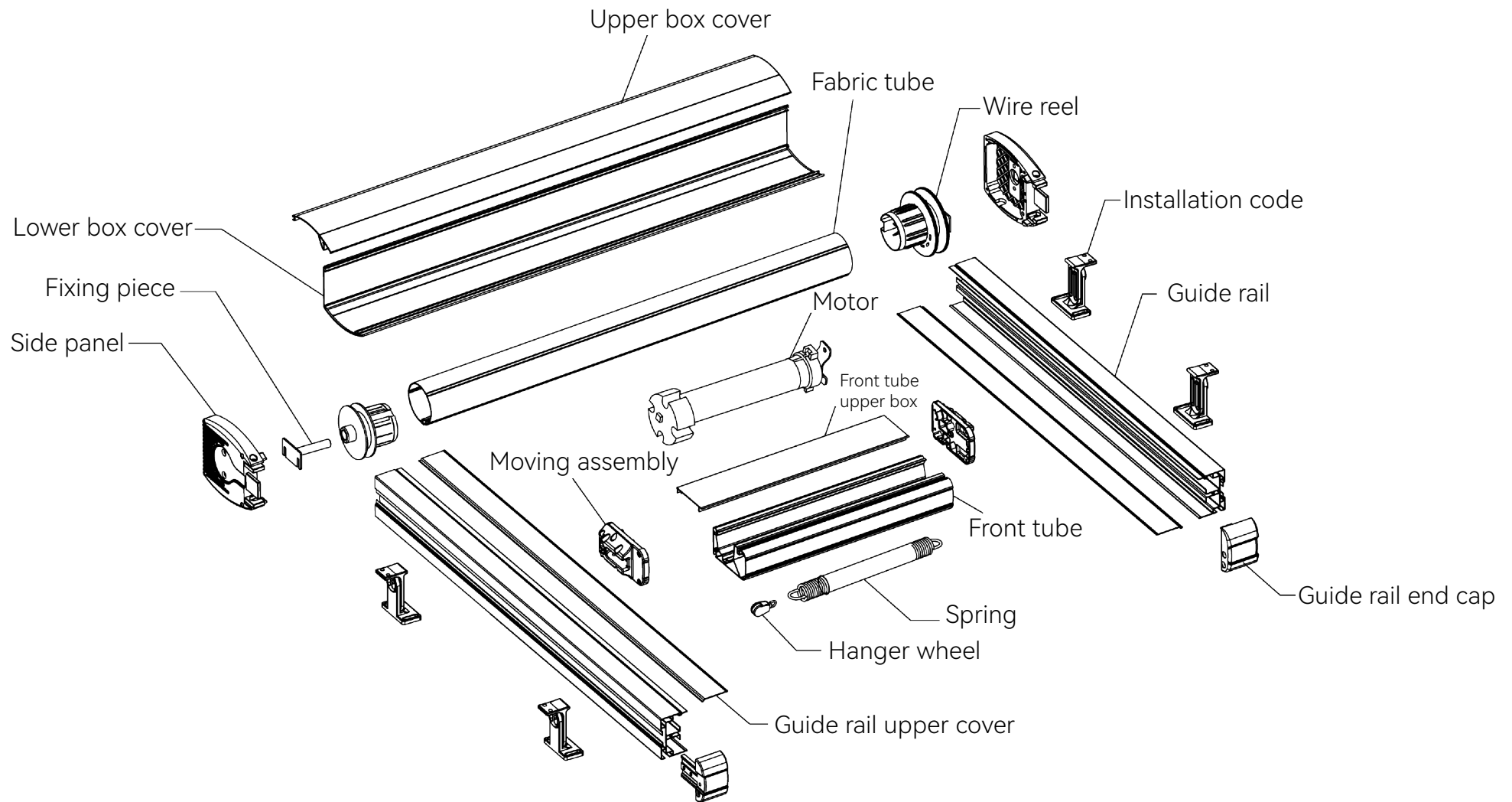







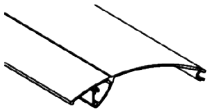

HAGENSTEEL Profiler®

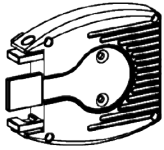
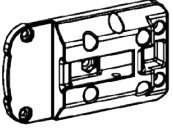
T06 External Roof Blind

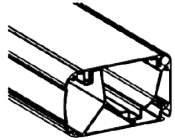
Horizontal Awning

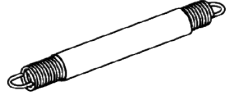
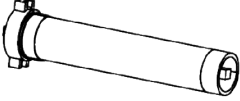
Product Accessories List

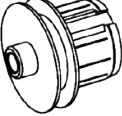
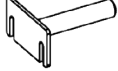
	Upper box cover		Lower box cover		Side panel
	Moving assembly		Installation code		Front tube
	Guide rail end cap		Spring		Motor
	Hanger wheel		Wire reel		Fixing piece

HAGENSTEEL Profiler®

T06 External Roof Blind

Horizontal Awning

Product Parameter Diagram

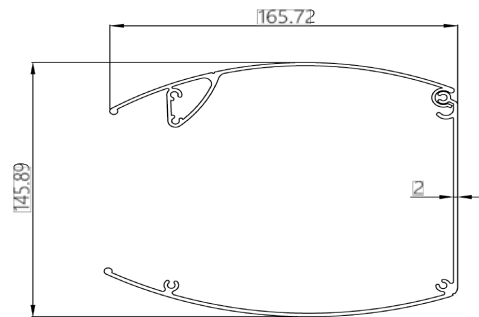
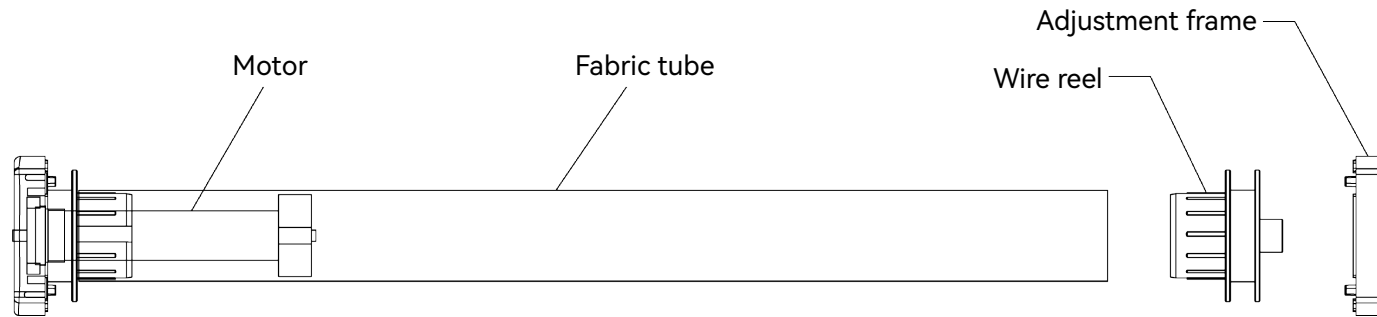

Upper and lower box covers

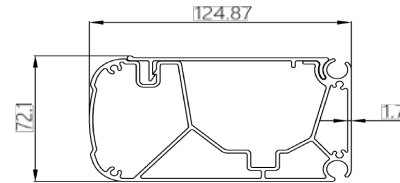

Front tube upper and lower boxes

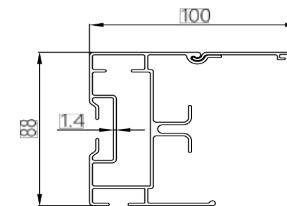

Guide rail

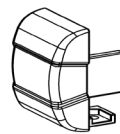

Guide rail end cap

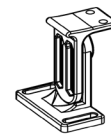

Installation code

HAGENSTEEL Profiler®

T06 External Roof Blind

Horizontal Awning

Product installation method

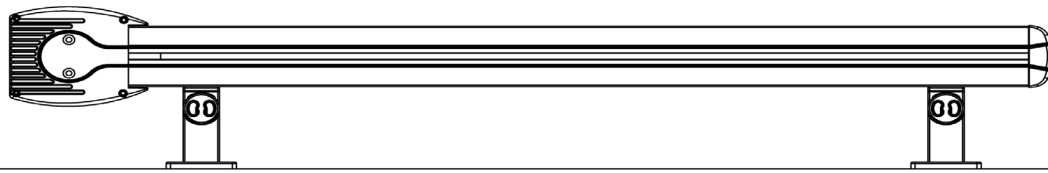

Adjustable flat installation

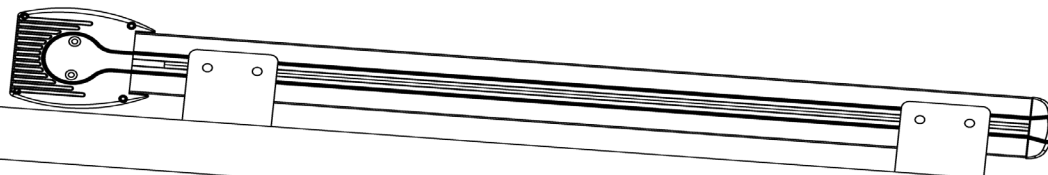

Flat installation

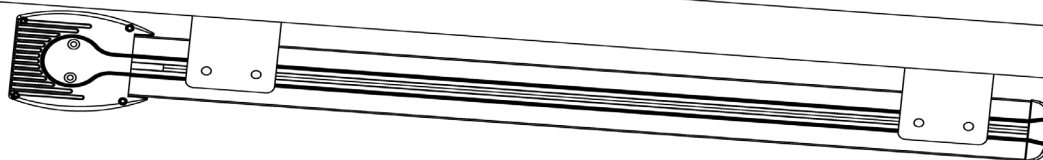

Hanging installation

HAGENSTEEL Profiler®

T06 External Roof Blind

Horizontal Awning

Product extension and retraction status



Open state



Closed state

HAGENSTEEL Profiler®

T06 External Roof Blind

Horizontal Awning

Product size specification

Extension (mm) \ Width (mm)	200	250	300	350	400	450	500	550	600
200	•	•	•	•	•	•	•	•	•
250	•	•	•	•	•	•	•	•	•
300	•	•	•	•	•	•	•	•	•
350	•	•	•	•	•	•	•	•	•
400	•	•	•	•	•	•	•	•	•
450			•	•	•	•	•	•	•
500			•	•	•	•	•	•	•
550					•	•			
600					•	•			

T06 External Roof Blind

Horizontal Awning

Product Cases

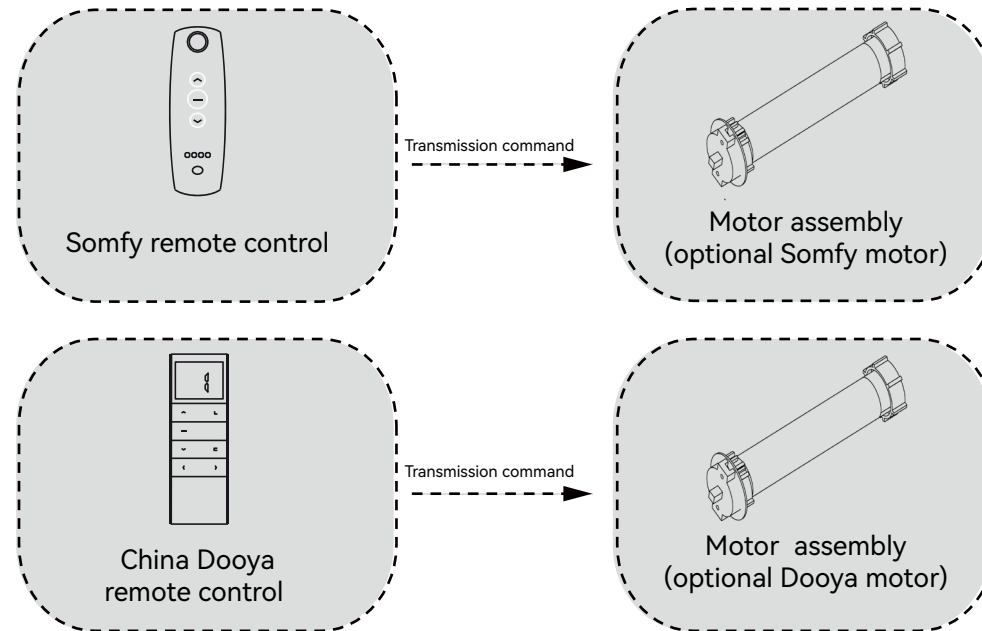

HAGENSTEEL Profiler®

T06 External Roof Blind

Horizontal Awning

Product Cases

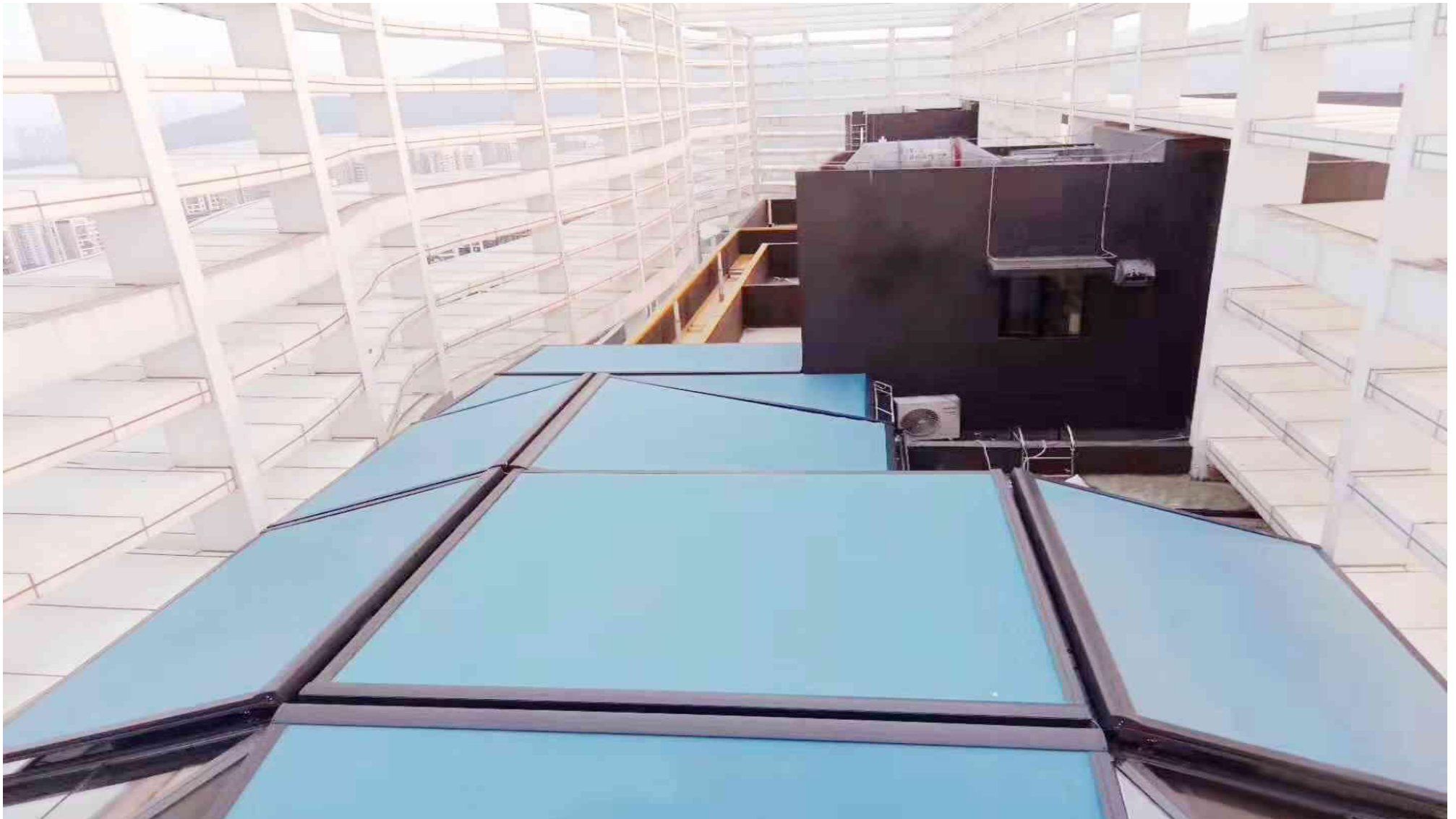

HAGENSTEEL Profiler®

T06 External Roof Blind

Horizontal Awning

Product Cases



HAGENSTEEL Profiler®

T06 External Roof Blind

Horizontal Awning

Product Cases



HAGENSTEEL Profiler®

T06 External Roof Blind

Horizontal Awning

Product Cases



HAGENSTEEL Profiler®

T06 External Roof Blind

Horizontal Awning

Product Cases



HAGENSTEEL Profiler®

T06 External Roof Blind

Horizontal Awning

Product Cases

